



YEA SHIN TECHNOLOGY CO., LTD
N-CHANNEL ENHANCEMENT
MODE FIELD EFFECT TRANSISTOR

2N7002E



FEATURES

- ◆ Low On-Resistance
- ◆ Fast Switching Speed
- ◆ Low-voltage drive
- ◆ Easily designed drive circuits
- ◆ Can protect against static electricity 1KV when the product is in use.

SOT-23

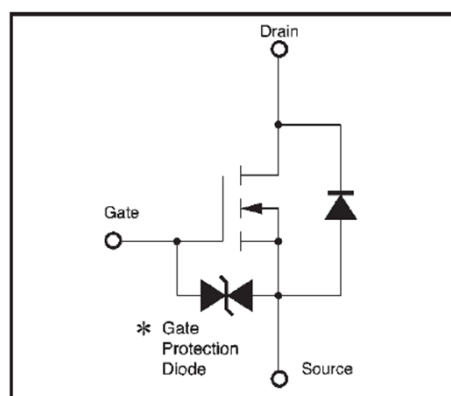
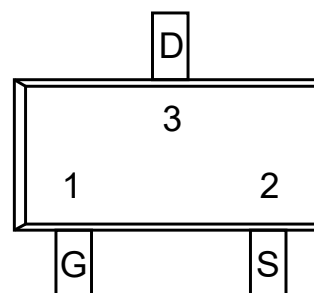

* A protection diode has been built in between the gate and the source to protect against static electricity when the product is in use. Use the protection circuit when fixed voltages are exceeded.

Maximum Ratings @ TA=25°C unless otherwise specified

Characteristic		Symbol	Value	Unit
Drain-Source Voltage		V_{DSS}	60	V
Gate-Source Voltage	Continuous	V_{GSS}	± 20	V
Drain Current	Continuous	I_D	115	mA
	Pulsed	I_{DP}^{*1}	800	mA
Reverse Drain Current	Continuous	I_{DR}	115	mA
	Pulsed	I_{DRP}^{*1}	800	mA
Total Power Dissipation		P_d^{*2}	225	mW
Channel Temperature		T_{ch}	150	°C
Storage Temperature Range		T_{stg}	-55 to +150	°C

*1 $PW \leq 10\mu s$, Duty cycle $\leq 1\%$.

*2 When mounted on a 1*0.75*0.062 inch glass epoxy board.

DEVICE CHARACTERISTICS

2N7002E

Electrical Characteristics @ TA=25°C unless otherwise specified, per element

Characteristic	Symbol	Min	Typ	Max	Unit	Test Condition
OFF CHARACTERISTICS						
Drain-Source Breakdown Voltage	$V_{(BR)DSS}$	60			V	$V_{GS}=0V, I_D=10\mu A$
Zero Gate Voltage Drain Current	I_{DSS}			1.0	μA	$V_{DS}=60V, V_{GS}=0V$
Gate-source Leakage	I_{GSS}			± 10	μA	$V_{GS}=\pm 20V, V_{DS}=0V$
ON CHARACTERISTICS						
Gate Threshold Voltage	$V_{GS(th)}$	1	1.85	2.5	V	$V_{DS}=10V, I_D=1mA$
Static Drain-Source On-Resistance	$R_{DS(ON)}$			7.5	Ω	$V_{GS}=10V, I_D=0.5A$
				7.5		$V_{GS}=10V, I_D=0.05A$
Forward Transfer Admittance	g_{fs}^*	80			mS	$V_{DS}=10V, I_D=0.2A$
DYNAMIC CHARACTERISTICS						
Input Capacitance	C_{iss}		25	50	pF	$V_{DS}=25V$
Output Capacitance	C_{oss}		10	25	pF	$V_{GS}=0V$
Reverse Transfer Capacitance	C_{rss}		3.0	5.0	pF	$f=1.0MHz$
SWITCHING CHARACTERISTICS						
Turn-On Delay Time	$T_{D(ON)}^*$		12	20	nS	$I_D=0.2A, V_{DD}=30V$
Turn-Off Delay Time	$T_{D(OFF)}^*$		20	30	nS	$V_{GS}=10V, R_L=150\Omega, R_G=10\Omega$

* $P_w \leq 300 \mu s$, Duty cycle $\leq 1\%$.

DEVICE CHARACTERISTICS

2N7002E

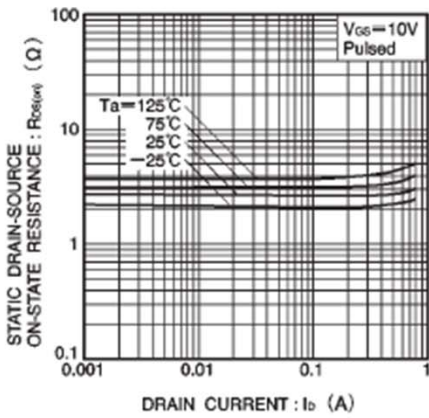

Fig.4 Static drain-source on-state resistance vs. drain current (I)

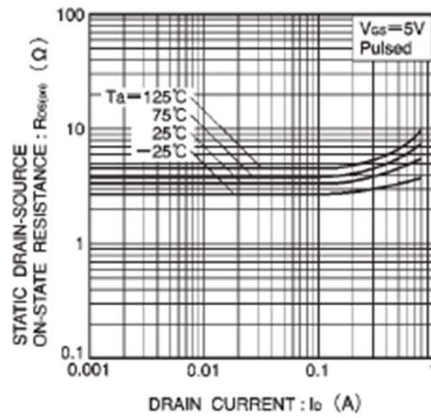

Fig.5 Static drain-source on-state resistance vs. drain current (II)

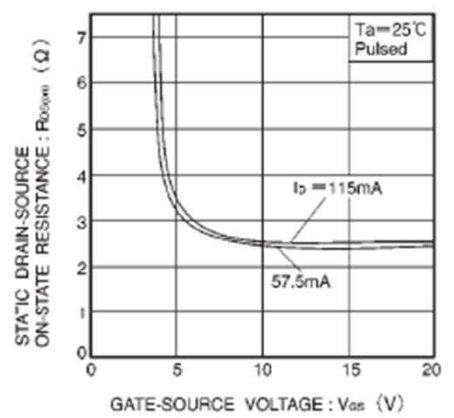

Fig.6 Static drain-source on-state resistance vs. gate-source voltage

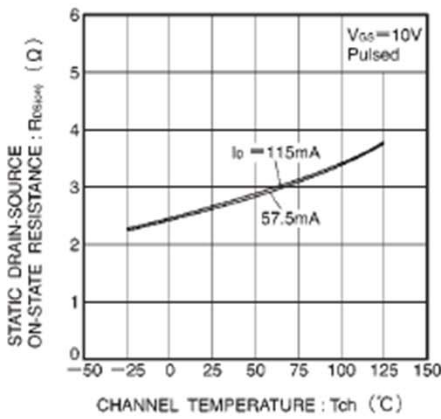

Fig.7 Static drain-source on-state resistance vs. channel temperature

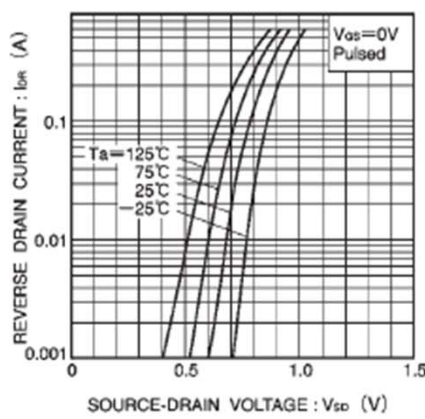

Fig.8 Reverse drain current vs. source-drain voltage (I)

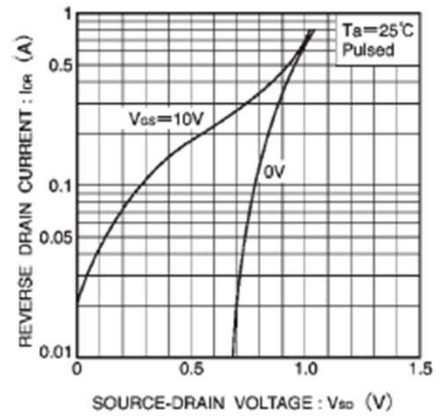

Fig.9 Reverse drain current vs. source-drain voltage (II)

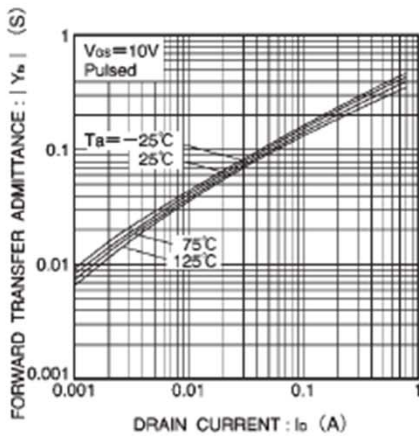

Fig.10 Forward transfer admittance vs. drain current

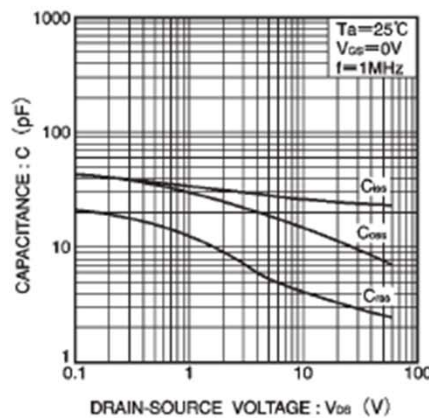

Fig.11 Typical capacitance vs. drain-source voltage

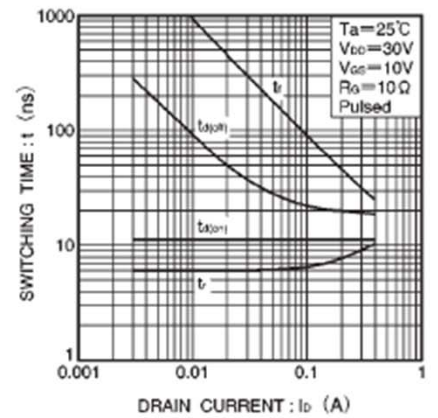

Fig.12 Switching characteristics (See Figures 13 and 14 for the measurement circuit and resultant waveforms)

PACKAGE OUTLINE & DIMENSIONS

2N7002E

SOT-23

NOTES:

1. DIMENSIONING AND TOLERANCING PER ANSI

Y14.5M, 1982.

2. CONTROLLING DIMENSION: INCH.

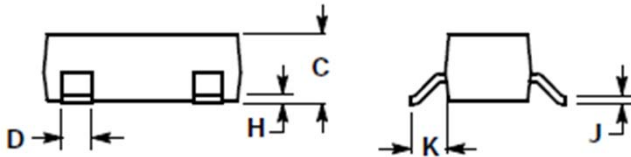
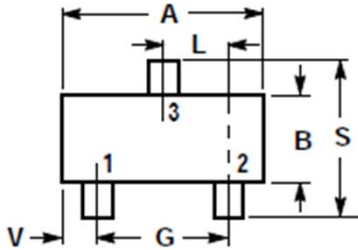

DIM	INCHES		MILLIMETERS	
	MIN	MAX	MIN	MAX
A	0.1102	0.1197	2.80	3.04
B	0.0472	0.0551	1.20	1.40
C	0.0350	0.0440	0.89	1.11
D	0.0150	0.0200	0.37	0.50
G	0.0701	0.0807	1.78	2.04
H	0.0005	0.0040	0.013	0.100
J	0.0034	0.0070	0.085	0.177
K	0.0140	0.0285	0.35	0.69
L	0.0350	0.0401	0.89	1.02
S	0.0830	0.1039	2.10	2.64
V	0.0177	0.0236	0.45	0.60

Suggested Pad Layout

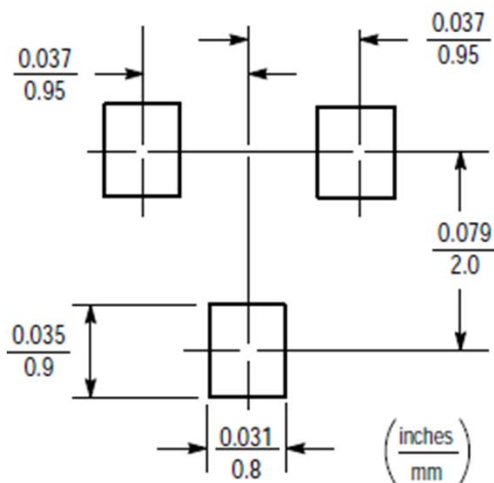

Marking Information

Device code : RS · K72

Date code : M

