

**N-CHANNEL ENHANCEMENT  
MODE FIELD EFFECT TRANSISTOR****FEATURES**

- Low On-Resistance
- Fast Switching Speed
- Low-voltage drive
- Easily designed drive circuits
- Can protect against static electricity 1KV when the product is in use.
- Marking : RS · 701

SOT-323 (SC-70)

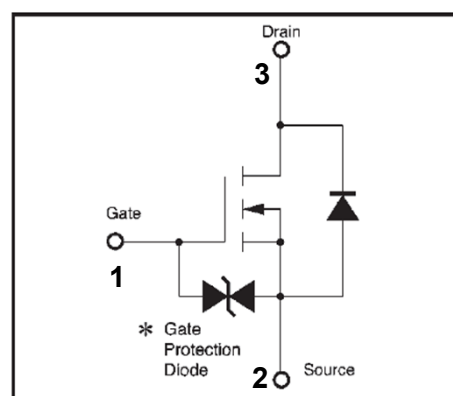
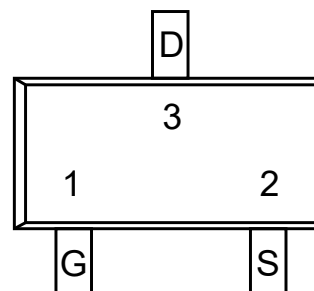

\* A protection diode has been built in between the gate and the source to protect against static electricity when the product is in use. Use the protection circuit when fixed voltages are exceeded.

**Maximum Ratings @ TA=25°C unless otherwise specified**

Characteristic	Symbol	Value	Unit
Drain-Source Voltage	$V_{DSS}$	60	V
Gate-Source Voltage	$V_{GSS}$	$\pm 20$	V
Drain Current	Continuous	$I_D$	115 mA
	Pulsed	$I_{DP}^{*1}$	800 mA
Reverse Drain Current	Continuous	$I_{DR}$	115 mA
	Pulsed	$I_{DRP}^{*1}$	800 mA
Total Power Dissipation	$P_d^{*2}$	225	mW
Channel Temperature	$T_{ch}$	150	°C
Storage Temperature Range	$T_{stg}$	-55 to +150	°C

\*1  $PW \leq 10\mu s$ , Duty cycle  $\leq 1\%$ .

\*2 When mounted on a 1\*0.75\*0.062 inch glass epoxy board.

# DEVICE CHARACTERISTICS

## 2N7002EW

### Electrical Characteristics @ TA=25°C unless otherwise specified, per element

Characteristic	Symbol	Min	Typ	Max	Unit	Test Condition
<b>OFF CHARACTERISTICS</b>						
Drain-Source Breakdown Voltage	$V_{(BR)DSS}$	60			V	$V_{GS}=0V, I_D=10\mu A$
Zero Gate Voltage Drain Current	$I_{DSS}$			1.0	$\mu A$	$V_{DS}=60V, V_{GS}=0V$
Gate-source Leakage	$I_{GSS}$			$\pm 10$	$\mu A$	$V_{GS}=\pm 20V, V_{DS}=0V$
<b>ON CHARACTERISTICS</b>						
Gate Threshold Voltage	$V_{GS(th)}$	1	1.85	2.5	V	$V_{DS}=10V, I_D=1mA$
Static Drain-Source On-Resistance	$R_{DS(ON)}$			7.5	$\Omega$	$V_{GS}=10V, I_D=0.5A$
				7.5		$V_{GS}=10V, I_D=0.05A$
Forward Transfer Admittance	$g_{fs}^*$	80			mS	$V_{DS}=10V, I_D=0.2A$
<b>DYNAMIC CHARACTERISTICS</b>						
Input Capacitance	$C_{iss}$		25	50	pF	$V_{DS}=25V$
Output Capacitance	$C_{oss}$		10	25	pF	$V_{GS}=0V$
Reverse Transfer Capacitance	$C_{rss}$		3.0	5.0	pF	$f=1.0MHz$
<b>SWITCHING CHARACTERISTICS</b>						
Turn-On Delay Time	$T_{D(ON)}^*$		12	20	nS	$I_D=0.2A, V_{DD}=30V$
Turn-Off Delay Time	$T_{D(OFF)}^*$		20	30	nS	$V_{GS}=10V, R_L=150\Omega, R_G=10\Omega$

\*  $P_w \leq 300 \mu s$ , Duty cycle  $\leq 1\%$ .

# DEVICE CHARACTERISTICS

## 2N7002EW

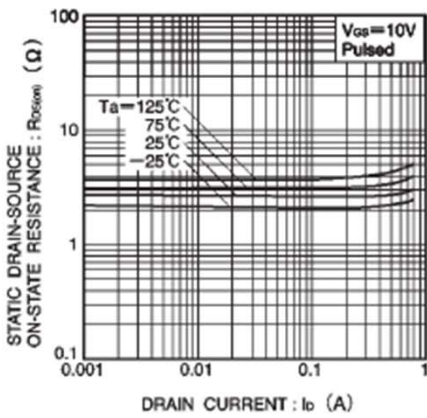

Fig. 4 Static drain-source on-state resistance vs. drain current ( I )

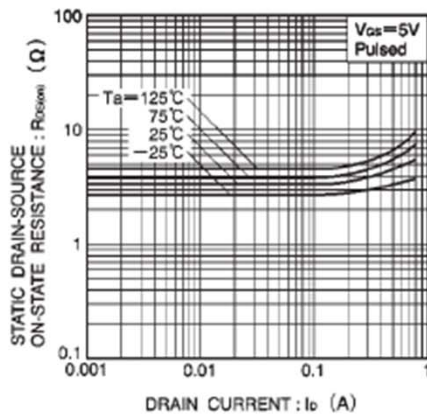

Fig. 5 Static drain-source on-state resistance vs. drain current ( II )

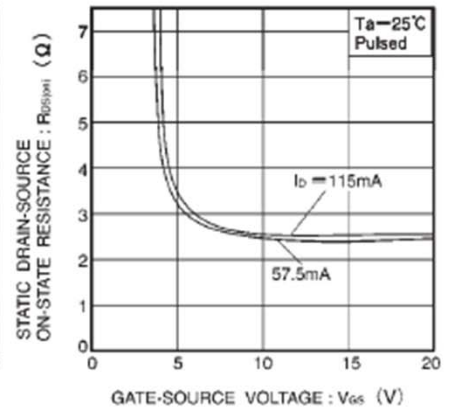

Fig. 6 Static drain-source on-state resistance vs. gate-source voltage

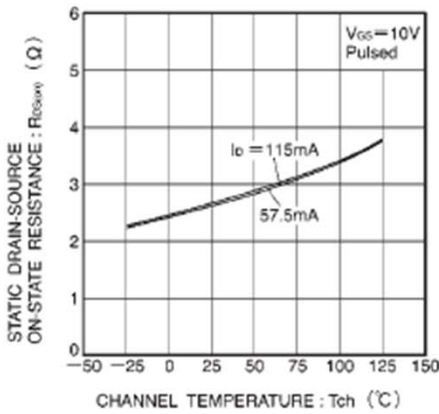

Fig. 7 Static drain-source on-state resistance vs. channel temperature

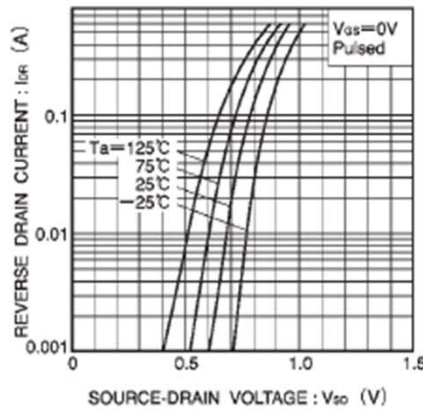

Fig. 8 Reverse drain current vs. source-drain voltage ( I )

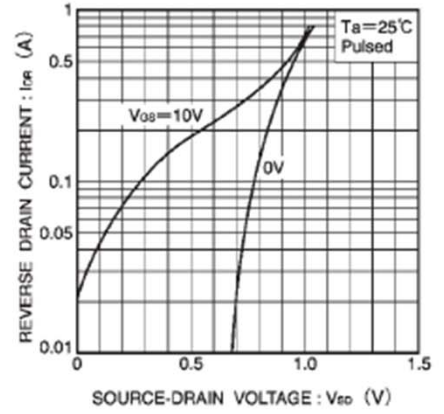

Fig. 9 Reverse drain current vs. source-drain voltage ( II )

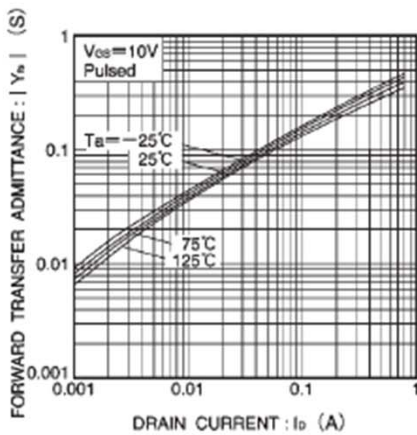

Fig. 10 Forward transfer admittance vs. drain current

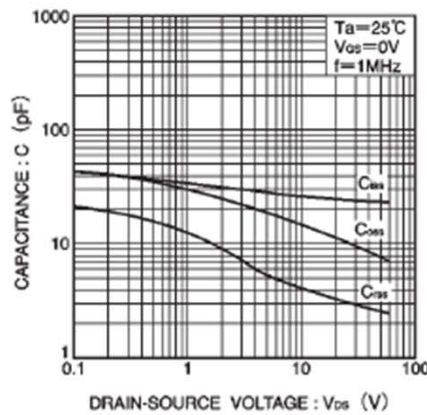

Fig. 11 Typical capacitance vs. drain-source voltage

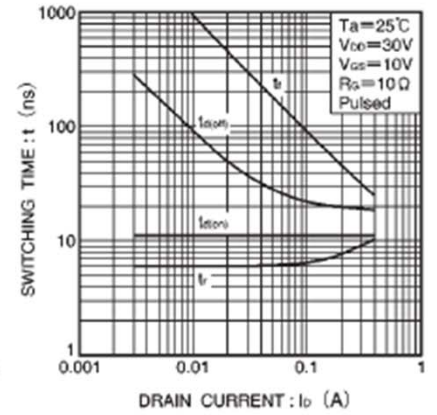

Fig. 12 Switching characteristics (See Figures 13 and 14 for the measurement circuit and resultant waveforms)

# PACKAGE OUTLINE & DIMENSIONS

## 2N7002EW

### SOT-323 (SC-70)

- NOTES:  
 1. DIMENSIONING AND TOLERANCING PER ANSI Y14.5M, 1982.  
 2. CONTROLLING DIMENSION: INCH.

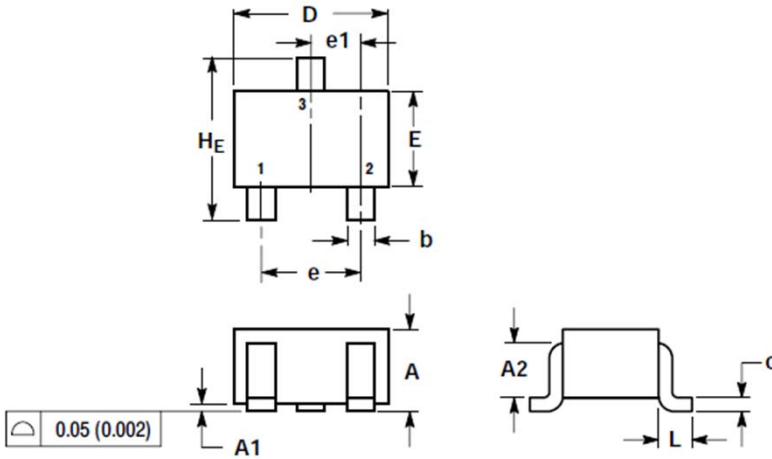

DIM	MILLIMETERS			INCHES		
	MIN	NOM	MAX	MIN	NOM	MAX
A	0.80	0.90	1.00	0.032	0.035	0.040
A1	0.00	0.05	0.10	0.000	0.002	0.004
A2	0.7 REF			0.028 REF		
b	0.30	0.35	0.40	0.012	0.014	0.016
c	0.10	0.18	0.25	0.004	0.007	0.010
D	1.80	2.10	2.20	0.071	0.083	0.087
E	1.15	1.24	1.35	0.045	0.049	0.053
e	1.20	1.30	1.40	0.047	0.051	0.055
e1	0.65 BSC			0.026 BSC		
L	0.425 REF			0.017 REF		
Hf	2.00	2.10	2.40	0.079	0.083	0.095

### SOLDERING FOOTPRINT

