

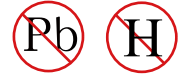

High Speed Switching Diodes



FEATURES

- Small surface mounting type
- High Speed
- High reliability with high surge current



SOD-523

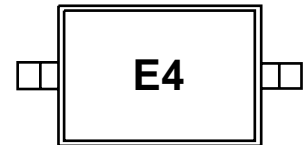

E4 :MARKING

Maximum Ratings and Electrical Characteristics, Single Diode @T_A= 25°C

Parameter	Symbol	Limits	Unit
Peak reverse voltage	V _{RM}	100	V
DC reverse voltage	V _R	85	V
Peak forward current	I _{FM}	500	mA
Mean rectifying current	I _O	150	mA
Junction temperature	T _j	125	°C
Storage temperature	T _{stg}	-55~+125	°C

Electrical Ratings @T_A= 25°C

Parameter	Symbol	Min.	Typ.	Max.	Unit	Conditions
Forward voltage	V _F			1.2	V	I _F =150mA
Reverse current	I _R			0.1	μA	V _R =85V
Capacitance between terminals	C _T			3.0	pF	V _R =0.5V, f=1MHZ
Reverse recovery time	t _{rr}			4	ns	V _R =6V, I _F =10mA, R _L =100Ω

DEVICE CHARACTERISTICS

1SS422

FIG. 1 - SURGE CURRENT CHARACTERISTICS

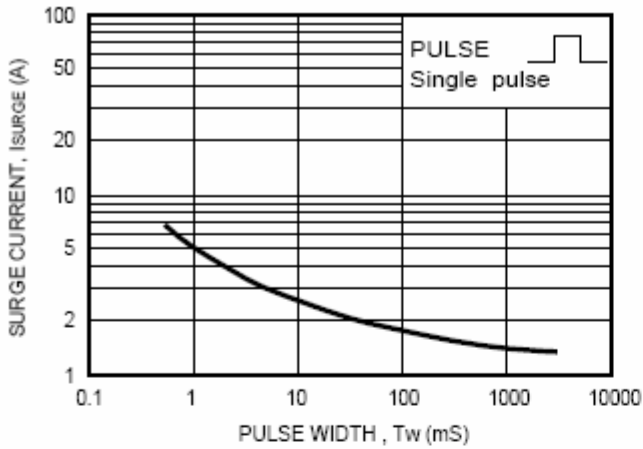

FIG. 2 - FORWARD CHARACTERISTICS

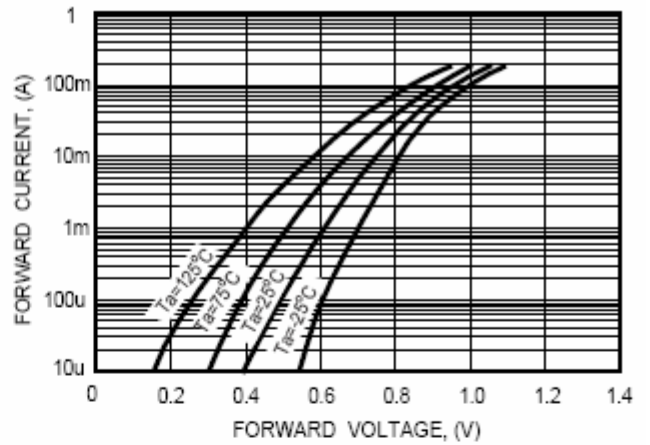

FIG. 3 - TYPICAL JUNCTION CAPACITANCE

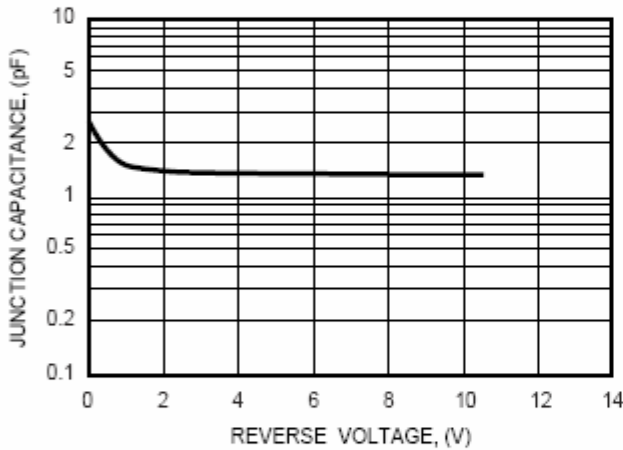

FIG. 4 - REVERSE CHARACTERISTICS

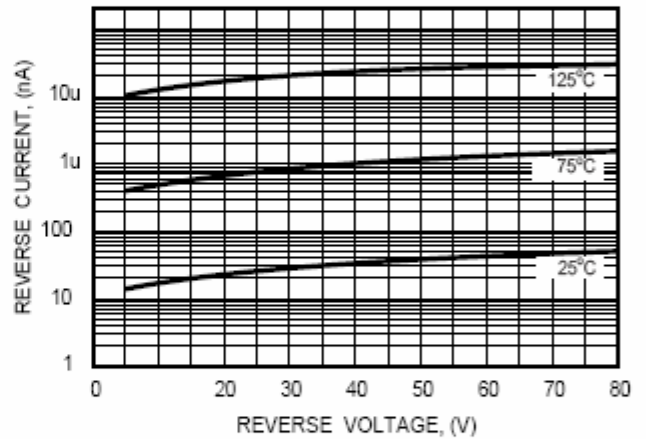

FIG. 5 - REVERSE RECOVERY TIME

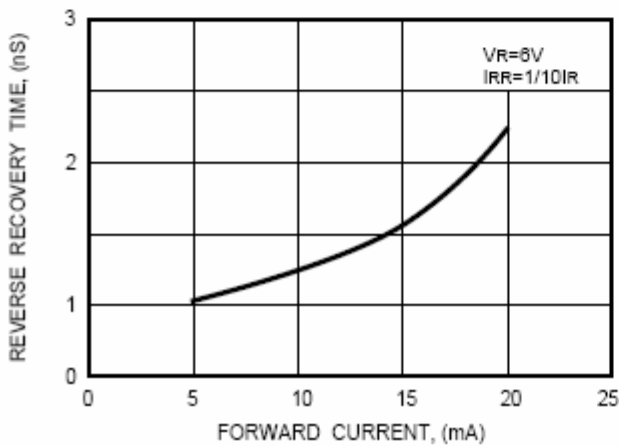
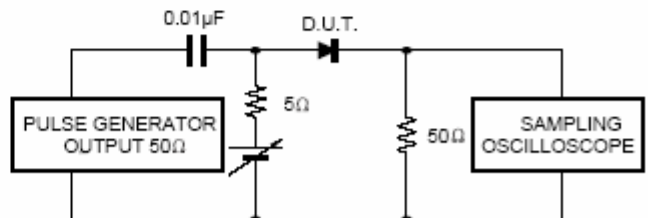

FIG. 6 - REVERSE RECOVERY TIME MEASUREMENT CIRCUIT



PACKAGE OUTLINE & DIMENSIONS

1SS422

SC-79/SOD-523

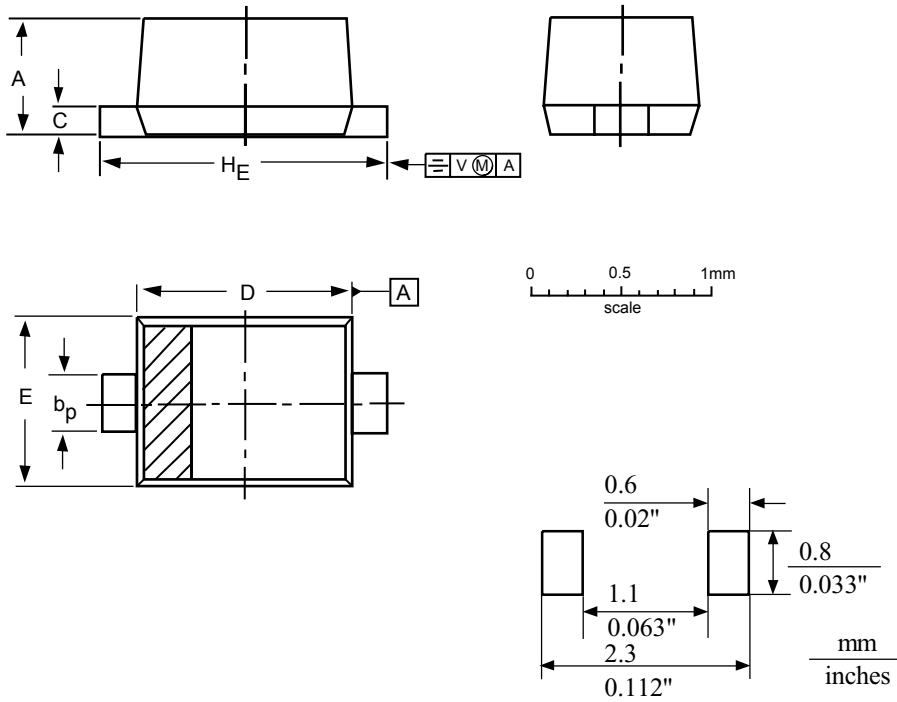

MOUNTING PAD

DIMENSIONS (mm are the original dimensions)

UNIT	A	b _p	c	D	E	H _E	V
mm	0.7	0.35	0.2	1.3	0.9	1.7	0.15
	0.5	0.25	0.1	1.1	0.7	1.5	

Note

- The banding indicates the cathode.

OUTLINE VERSION	REFERENCES			EUROPEAN PROJECTION	ISSUE DATE
	IEC	JEDEC	EIAJ		
SOD-523			SC-79		98-11-25