

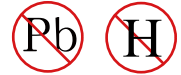

Ultra High Speed Switching Diode



Features

- Low forward voltage :  $V_{F(3)} = 0.9V$  (typ.)
- Fast reverse recovery time :  $t_{rr} = 1.6ns$  (typ.)
- Small total capacitance :  $C_T = 0.9pF$  (typ.)

Marking : C3

SOT-23 (TO-236AB)

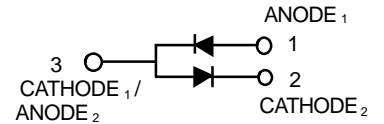
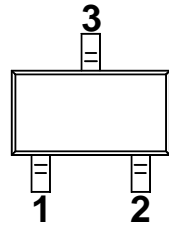

Maximum Ratings ( $T_A = 25^\circ C$ )

Characteristic	Symbol	Rating	Unit
Maximum (peak) reverse voltage	$V_{RM}$	85	V
Reverse voltage	$V_R$	80	V
Maximum (peak) forward current	$I_{FM}$	300 *	mA
Average forward current	$I_O$	100 *	mA
Surge current (10ms)	$I_{FSM}$	2 *	A
Power dissipation	P	150	mW
Junction temperature	$T_j$	125	$^\circ C$
Storage temperature range	$T_{slg}$	-55~+125	$^\circ C$

\* : Unit rating. Total rating = Unit rating  $\times$  0.7.

Electrical Characteristics ( $T_A = 25^\circ C$ )

Characteristic	Symbol	Test Circuit	Test Condition	Min	Typ.	Max	Unit
Forward voltage	$V_{F(1)}$	—	$I_F = 1mA$	—	0.60	—	V
	$V_{F(2)}$	—	$I_F = 10mA$	—	0.72	—	
	$V_{F(3)}$	—	$I_F = 100mA$	—	0.90	1.20	
Reverse current	$I_{R(1)}$	—	$V_R = 30V$	—	—	0.1	$\mu A$
	$I_{R(2)}$	—	$V_R = 80V$	—	—	0.5	
Total capacitance	$C_T$	—	$V_R = 0, f = 1MHz$	—	0.9	3.0	pF
Reverse recovery time	$t_{rr}$	—	$I_F = 10mA$ (Fig.1)	—	1.6	4.0	ns

# DEVICE CHARACTERISTICS

## 1SS226

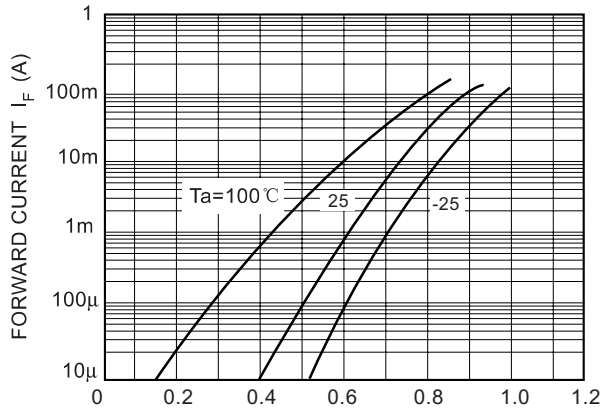

Fig.1 FORWARD VOLTAGE  $V_F$ (V)

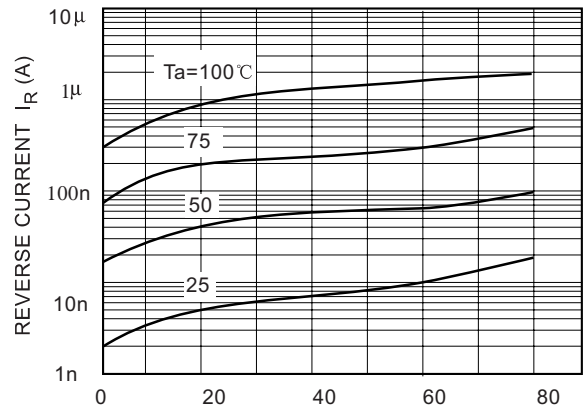

Fig.2 REVERSE VOLTAGE  $V_R$ (V)

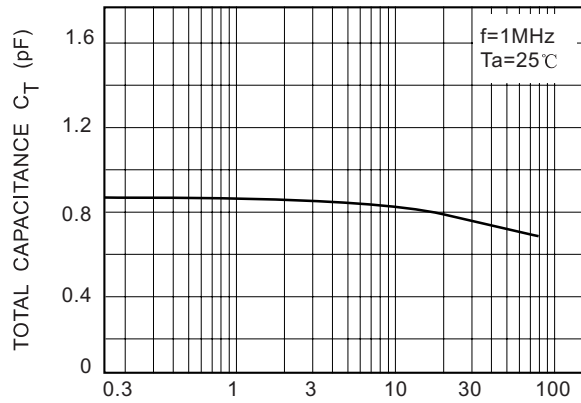

Fig.3 REVERSE VOLTAGE  $V_R$ (V)

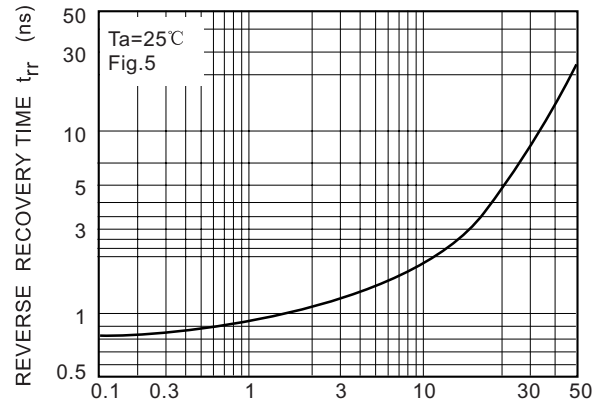

Fig.4 FORWARD CURRENT  $I_F$ (mA)

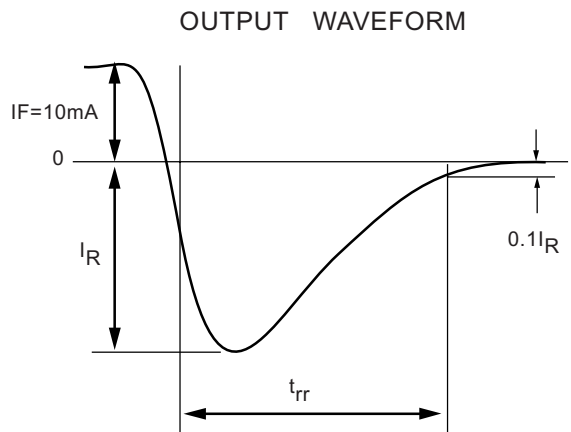
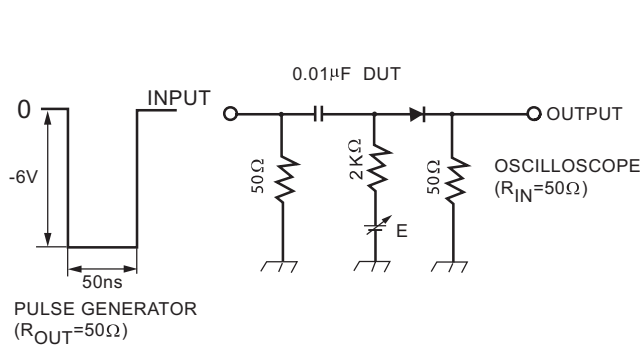

Fig.5 Reverse recovery time ( $t_{rr}$ ) test circuit

# PACKAGE OUTLINE & DIMENSIONS

## 1SS226

### SOT-23

NOTES:

1. DIMENSIONING AND TOLERANCING PER ANSI Y14.5M,1982
2. CONTROLLING DIMENSION: INCH.

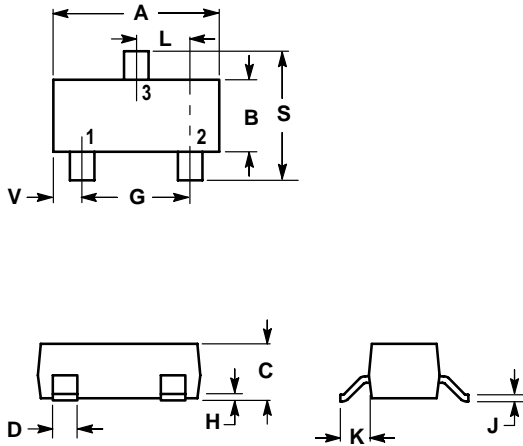

DIM	INCHES		MILLIMETERS	
	MIN	MAX	MIN	MAX
A	0.1102	0.1197	2.80	3.04
B	0.0472	0.0551	1.20	1.40
C	0.0350	0.0440	0.89	1.11
D	0.0150	0.0200	0.37	0.50
G	0.0701	0.0807	1.78	2.04
H	0.0005	0.0040	0.013	0.100
J	0.0034	0.0070	0.085	0.177
K	0.0140	0.0285	0.35	0.69
L	0.0350	0.0401	0.89	1.02
S	0.0830	0.1039	2.10	2.64
V	0.0177	0.0236	0.45	0.60

